

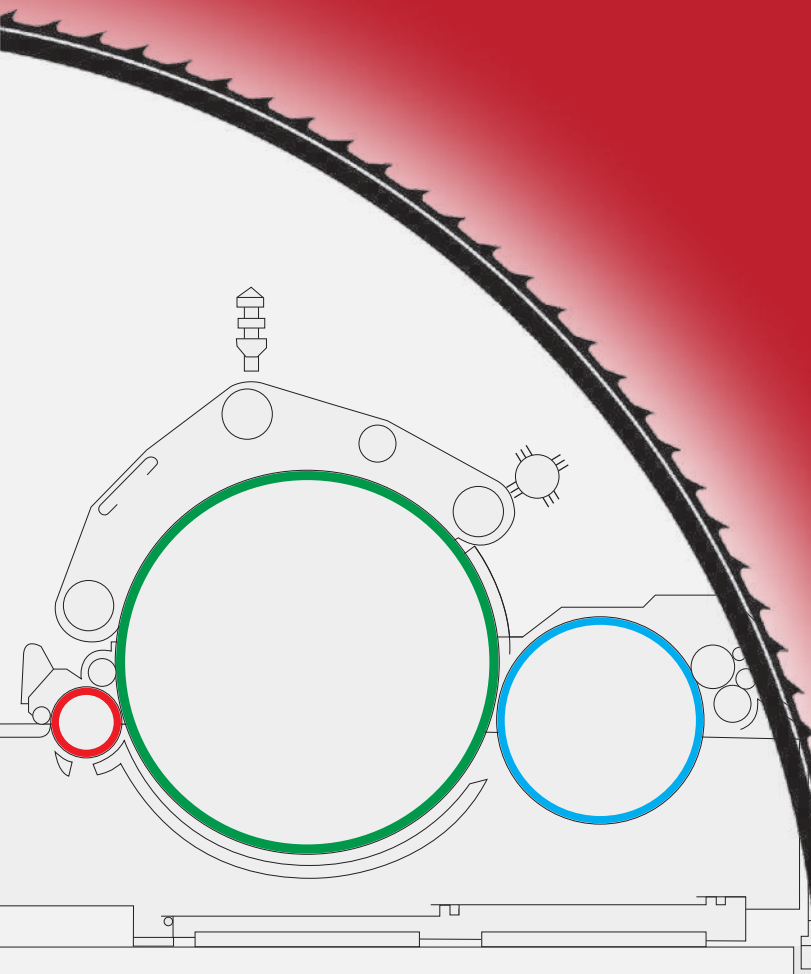

# Sanmit Card Clothing India (P) Ltd

- ◆ C- System
- ◆ Carding Plates (Steel & Aluminium)
- ◆ Steel Mote Knives
- ◆ Brush Conversion Kit
- ◆ Fillets
- ◆ Carding Accessories



- ◆ Cylinder Wires
- ◆ Doffer Wires
- ◆ Lickerin Wires
- ◆ Blow Room Beater Wires
- ◆ Border Wires

## Stationary Flat Tops

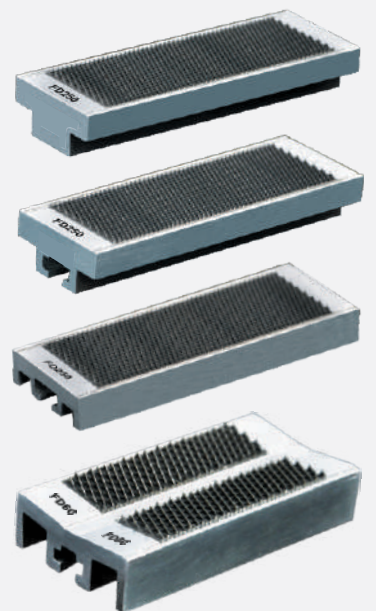

# Stationary Flat Tops

## Type-H (Threaded Type)

### Sanmit Products fit for all 40" Cards

S.No.	Sanmit Model
1.	LC300A (Front - SFD)
2.	LC300A - V3 (Front & Back) & LC300A - V4 (Front & Back)
3.	LC 333 / 361 & 363 SFL= 8F + 2K SFD = 4Flats / 5 Flats
4.	C.1/2, C.1/2a, C.1/3 & 100 (Front & Back) C - System and C-Factors for all Card
5.	Sanmit C - System for SFL & SFD for C.1/3, 300, 300A, 300A - V3/V4.

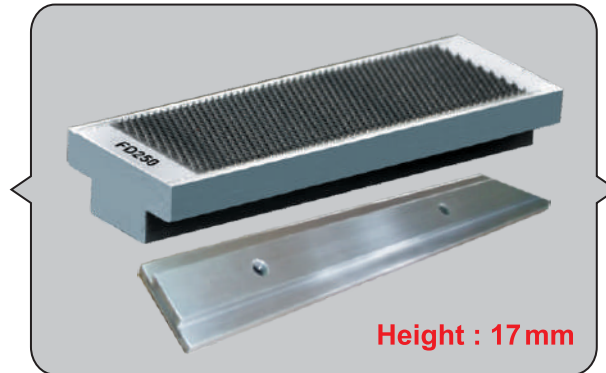

PPSI
FD 90 A
FD 150 A
FD 250 A
FD 350 A
FD 450 A
FD 550 A
FD 650 A

### Sanmit Products fit for all 40" Cards

S.No.	Sanmit Model
1.	LC 300 (SFD - Front & SFL - Back), 300A (SFL - Back Side) & 333 (Under Licker - in)
2.	D-K760, D-K760 - old, D-K780, D-K800 & D-K803 (Existing 3 Flat C - System)
3.	D-K803 & D-K903 (Under Licker - in Segments)
4.	Sanmit C - System for all cards (Screw type)

## Type-A (Screw Type / Slot Type)

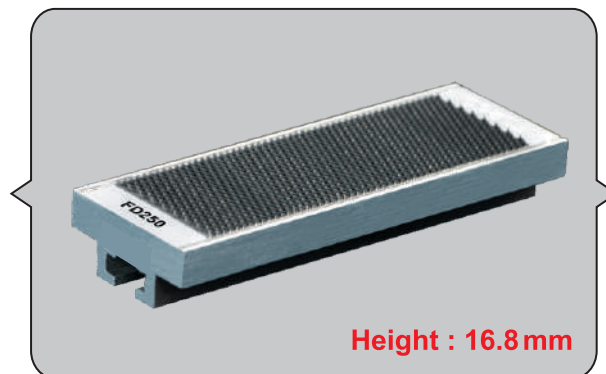

PPSI
FD 90 A
FD 150 A
FD 250 A
FD 350 A
FD 450 A
FD 550 A
FD 650 A

### Sanmit Products fit for all 60" Cards

S.No	Sanmit Model
1.	INGOLSTADT - SSKU12

### Sanmit Products fit for all 40" Cards

S.No	Sanmit Model
1.	D-K715, D-K740, D-K760 (Aluminium Base), D-K800 (Twin Flat), D-K803 (Twin Flat), D-K903, T-C 03 / 05 / 06 / 07-S / 08 / 11 / 15 & All Twin Flat System Carding Machines
2.	MK - 4, MK - 5, MK - 5A, MK - 5B, MK - 5C, MK - 5D, MK - 6 & MK - 7
3.	C.1/2, C.1/2a, C.1/3, T.C 360, I.C.C T.C 450, C 4, C 10, C 50 & C 51
4.	HOWA- CMSK - 3, CMSK - 4 & CMSK - 5, CM300 & CMS80
5.	TOYODA & TOYODA MEIKIN All model
6.	JFA 186, JFA 201, JFA 203, JFA 203A, JFA 203B, JFA 212, JFA 225, JFA 226, JFA 227, JFA 228, JFA 231C, JWF 1203, JWF 1204 & all other CHINESE cards
7.	I.C.C - C - System & Under Licker - in Segments for all Carding Machines
8.	JAPANESE All Carding machines
9.	C 40, C41, CX 300, CX 400, CX 501 & CX 601 (Front, Back & Under Licker-in)
10.	LC 361 & 363 Twin Flat (SFL / SFD)

## Type-B (Screw Type / Slot Type)

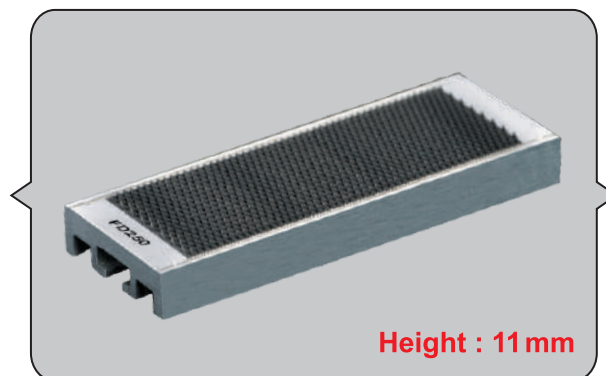

PPSI
FD 90 A
FD 150 A
FD 250 A
FD 350 A
FD 450 A
FD 550 A
FD 650 A

### Sanmit Products fit for all 50" Cards

S.No	Sanmit Model
1.	T-C 11 / 15
2.	Chinese JSFA 326 / 328 / 328A / JSC-6 Auto Card

### Sanmit Products fit for all 60" Cards

S.No	Sanmit Model
1.	C60, C61 & C70 / Chinese C601
2.	Marzoli C601 & C701
3.	LC 636

# Stationary Flat Tops

## Sanmit Products

Under Lickerin Segments - Suitable for 40" cards

S.No.	Sanmit Model
1.	D-K715, D-K740, D-K760, D-K780 & D-K800
2.	C.10, C.50 & C.51
3.	C.1 /2, C.1/2a, C.1/3, 100, 300, 300A, 300A-V3, 300A-V4, 361, 363, T-C360, T-C450 & other 40" cards
4.	JFA 186, JFA 201, JFA 203, JFA 203A, JFA 203B, JFA 212, JFA 225, JFA 226, JFA 227, JFA 228, JFA 231C, JWF 1203, JWF 1204 & other CHINESE cards
5.	BLOW ROOM CVT - 3 & CVT - 4 (FD 40)

## Type-C (Slide Type)

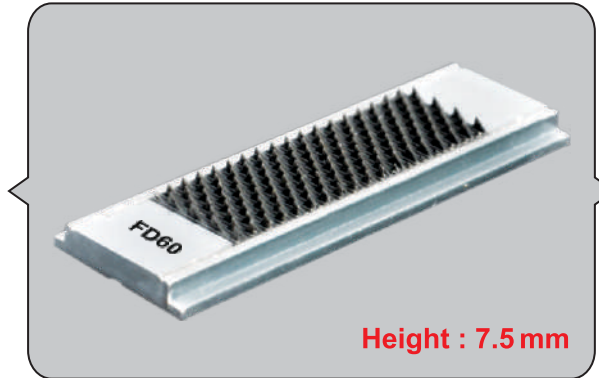

PPSI
FD 60
FD 90

## Sanmit Products fit for all 40" cards

S.No.	Sanmit Model
1.	MK - 4 & MK - 5 (Clip type C - System)
2.	D-K715, D-K740 & D-K760 (Cast Iron & Al. C - System)
3.	JFA 186, JFA 201A, JFA 201B, JFA 231A, JFA 221D, C - System & Chinese Cards
4.	HOWA - CMSK 3 & CMS 80 / TOYODA - CK7 & TOYODA MEIKIN
5.	Clip Type C - System for all Carding Machines

## Type-G (Clip Type)

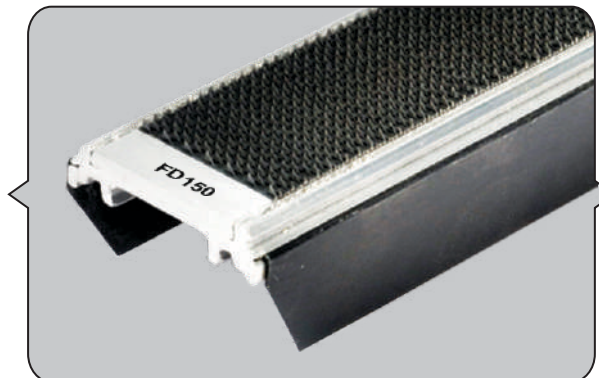

PPSI
FD 90 A
FD 150 A
FD 250 A
FD 350 A
FD 450 A
FD 550 A
FD 650 A

## Sanmit Products

Under Lickerin Segments - Suitable for 40" cards

S.No.	Sanmit Model
1.	T-C03 / 05 / 5-3 / 06 / 07-S / 08 / 10

## Type-F (Screw Type)



PPSI
FD 90

# Stationary Flat Tops

## Type-D (Slide Type)

### Sanmit Products for UNIFLEX Carding Segment

S.No.	Sanmit Model
1.	B60 (Uniflex)



PPSI  
FD 4

Height : 7.5 mm

## Type-E (Slide Type)

### Sanmit Products Under Lickerin Segments - Suitable for 40" cards

S.No.	Sanmit Model
1.	C4



PPSI  
FD 60

Height : 10 mm

## Type-K (Twin Row)



PPSI  
FD 60

Original Cast Iron Underlickerin Segments for D-K715 / D-K740 Cards.

## Type-L (Slide Type)

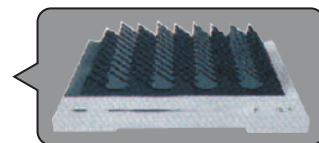

PPSI  
FD 60

ECC Underlickerin Segments for HOWA Cards.

## Salient Features

- ❖ Aluminium end caps with extra locking punch holes ensures double safety for SF wires.
- ❖ Scratch free Aluminium coating gives better aesthetic appearance.
- ❖ Burr free and smooth finish, protects the fibre from breakage as a more gentle carding action results highest yarn strength.
- ❖ Higher nep removal efficiency and lower shot fibre content after the initial mounting and throughout the service.
- ❖ Long service life and greater added value.

# Combing Segment (Licker-in) / RSK Pin Beater Segment

## Salient Features

Construction of assembly is replaceable slide (strip) type.

Economic replacement for conventional araldite and punched sheets combing segments.

Sharp points gives better pre-openings that results in minimum loss of good fibres.

Aluminium combing bars are made out of alloy grade smooth finish extrusion materials which gives flat stability.

Machine original mote knives can be fixed without any alterations in assembly.

Easy replaceable and cost economic during replacement time.

**Suitable:** C.1/2, C.1/2a, C.1/3, 100, 300, 300A & 300A - V3 / 300A - V4.

## Combing Segment - Economic Model (2 Aluminium Bar + 4 Strips)

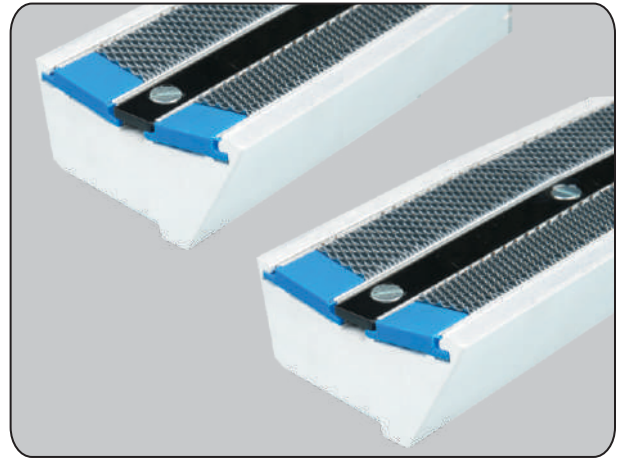

## Pre Opening Combing Segments - (Individual Gauging)

### Salient Features

Construction of assembly is individual gauge setting and replaceable slide (strip) type.

Individual gauge setting ensures accurate gauging which results in better opening of fibre tufts in lickerin zone.

Sharp points gives better pre-opening that results in minimum loss of good fibres.

High quality hardened mote knives help to remove smaller and heavier trash particles results good reduction of neps in lickerin zone.

Made out of high grade individual flat aluminium bars which gives more stability to ensure accurate gauging.

**Suitable:** D-K715, D-K740, MK4 & MK5.

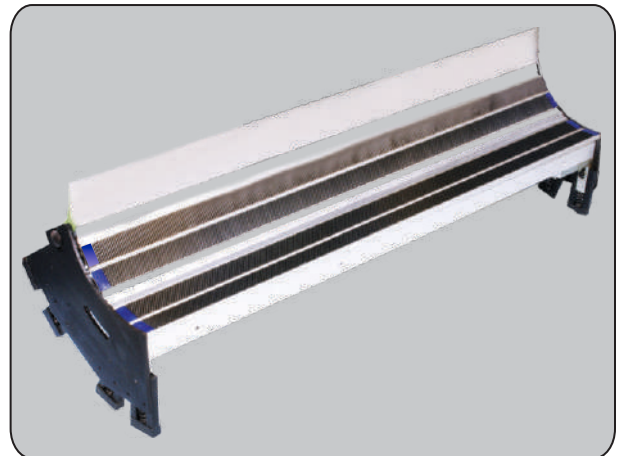

## ERM Pin Beater Segments



## RSK Pin Beater Segments



### Sanmit Model

ERM 5/5 (Flexi Clean)	GBR Beater
B2/4R & ERM 5/6 (Flexi Clean)	Krishner Beater
LB6/1 - Krishner Beater	Step Cleaner
RN - Beater, RK - Beater	MK5 & MK6

### Sanmit Model

RSK-1200
RSK-1600

**Suitable:** Open End & Fine Spinning

# New Generation C-System

## SFL (Above Lickerin) & SFD (Above Doffer)

### SFL (Above Lickerin)

Stationary flats are designed from coarser PPSI - bottom to Finer PPSI - top gives excellent pre opening of heavier fibre tufts. Mote knife and suction device removes trash particles and even distribution of fibres.

### SFD (Above Doffer)

Finer PPSI stationary flats, mote knife and smooth finish suction device helps to improve classmate results.

### Salient Features

Machine originality will be maintained during modification.

Imported high quality stationary flat tops wires ensures yarn sliver quality and consistency in life.

It gives good parallelization of fibres and results reduces the carding strain and increases the life of cylinder wire and revolving flats.

Sturdy Al. base beam with Individual adjustment of stationary flats and mote knife makes accurate gauging which helps carding quality and production at higher speeds.

Smooth finish suction device helps to remove micro dusts, short fibres and motes and help to maintain clean suction in the machine.

No gap between each flat prevents dust liberation. No need for sticking forms between each flat.

Big suction device prevent air curling which ensures no suction chocking during card running.

Aluminium flats are made out of alloy grade smooth finish extrusion materials which gives flat stability.

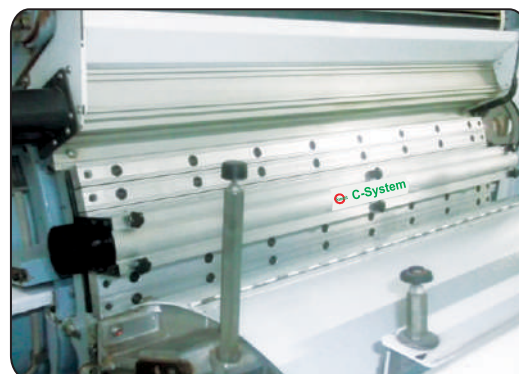

## Recommendation & Scope of Supply

\*\* F - Flats / K - Knife

Card Model	Above Doffer (SFD)	Above Licker-In (SFL)	Pre Opening Combing Segments (Under Licker-In)	Process
D-K715 & D-K740	5 F + 1 K + Suction	7 F + 1 K + Suction	4 Segments + 2 K	Cotton / Synthetic
	9 F	11 F		
	5 F + 1 K + Suction	7 F + 2 K + Suction		
D-K760 D-K780, D-K800 & D-K803 (Single Licker in)	6 F + 1 K + Suction	8 F + 1 K + Suction	-	Cotton / Synthetic
		7 F + 2 K + Suction		
D-K800 - Twin Flat (Single Licker in)	6 F + 1 K + Suction	8 F + 1 K + Suction	-	Cotton / Synthetic
D-K803 & D-K903 (3 Licker - in - Twin Flat)	6 F + 1 K + Suction	6 F + 1 K + Suction	-	Cotton / Synthetic
D-K760 (Cast Iron base C-System)	6 F + 1 K + Suction	7 F + 1 K + Suction	-	Cotton / Synthetic
MK - 3	6 F + 1 K + Suction	12 F + 1 K + Suction	-	Cotton / Synthetic
MK - 4 & MK - 5	6 F + 1 K + Suction	8 F + 1 K + Suction	4 Segments + 2 K	Cotton / Synthetic
C4 & C10	4F + 1 K + Suction	8 F + 1 K + Suction	-	Cotton / Synthetic
C50 & C51	7 F + 1 K + Suction	7 F + 1 K + Suction	4 Segments + 2 K	Cotton / Synthetic
C60, C61 & C601	6 F + 1 K + Suction	8 F + 2 K + Suction		
LC300, 300A 300A - V3 & 300A - V4	4 F + 1 K + Suction	8 F + 2 K + Suction	Economic Model Combing Segment Full Set	Cotton / Synthetic
	6 F + 1 K + Suction			
C.1/2, C.1/2a, C.1/3 (Economic model)	6 F + 1 K + Suction	3 F	Economic Model Combing Segment Full Set	Cotton / Synthetic

Also Available for Chinese FA201 / FA186, HOWA - CMS80 & CMSK3, TOYODA MEIKIN

# Fillets

## DK 715, 740, 760, 780, 800, 803, 903 & TC 03, 05, 5/1, 5/3, 07, 08, 10, 11 & 15 CARDS

S.No	Description	Specification	Qty/ Card
1.	Doffer cleaning fillet TR AP No.26	15.0 mtrs x 20 mm	15 mtrs
2.	Cleaning fillet TR DP 18 – 1	10.5 mtrs x 28 mm	10.5 mtrs
3.	Stripping fillet TR DS 609	9.0 mtrs x 40 mm	9.0 mtrs
4.	Cleaning fillet TR AP No.26 (TC11/15)	20 mtrs x 20 mm	20 mtrs
5.	Cleaning fillet TR DP No.18-1 (TC11/15)	14 mtrs x 28 mm	14 mtrs
6.	Stripping fillet TR DS 609 (TC11/15)	12 mtrs x 40 mm	12 mtrs

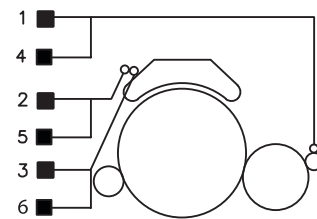

## 100 / 300 / 300A / 300AV3 / 300AV4 / 333 / 361 / 363 CARDS

S.No	Description	Specification	Qty/ Card
1.	Zig-Zag No.10(LC 100)	8.6 mtrs x 38 mm	8.6 mtrs
2	CRC Doffer Cleaning Fillet	15 0 mtrs x 20 mm	15 0 mtrs

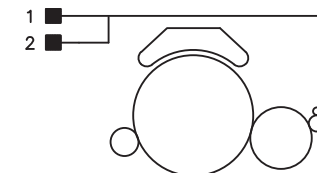

## C1/1, C1/2, C1/3 & TEXTTOOL-TC360,450 & SHANTHI SC2 CARDS

S.No	Description	Specification	Qty/ Card
1.	CRC Doffer Cleaning Fillet	11 mtrs x 28 mm	11 mtrs
2.	Flat stripping (26.5 mm ht)	11.5 mtrs x 38 mm	11.5 mtrs

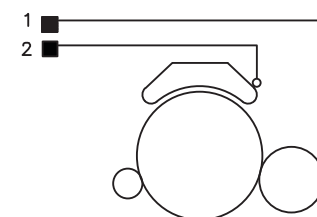

## C4 / C4A / C10 & Marzoli Card

S.No	Description	Specification	Qty/ Card
1.	Zig - Zag No. 10	8 mtrs x 40 mm	7.5 mtrs
2.	Special CRC	11 mtrs x 28 mm x 7.5 mm	11 mtrs

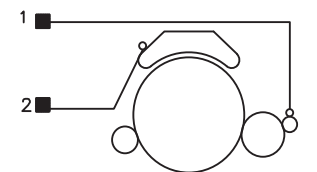

## C50 / C51 CARD

S.No	Description	Specification	Qty/ Card
1.	Clearer roller clothing CF50	13.0 mtrs x 20 mm	13.0 mtrs

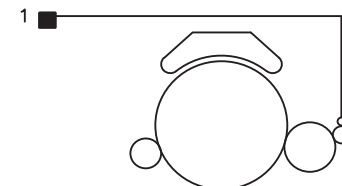

## C70 CARD

S.No	Description	Specification	Qty/ Card
1	Cleaning fillet TR DP 18-1	15 mtrs x 28 mm	15 mtrs
2	Stripping fillet TR DS 609	14 mtrs x 40 mm	14 mtrs
3.	Doffer Cleaning Fillet TRAP 26	21 mtrs x 20 mm	21 mtrs

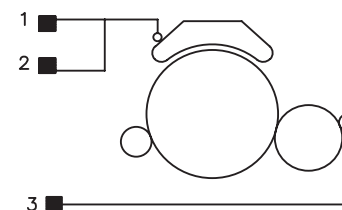

## MK4, MK5, MK6 & MK7 CARDS

S.No	Description	Specification	Qty/ Card
1 .	Stripping Fillet DS- 609 (MK6)	11.0 mtrs x 40 mm	11 mtrs
2 .	Cleaning Fillet DP 18 -1 (MK6)	12.5 mtrs x 28 mm	12.5 mtrs
3.	Dicky Fillet	16.0 mtrs x 20 mm	16.0 mtrs

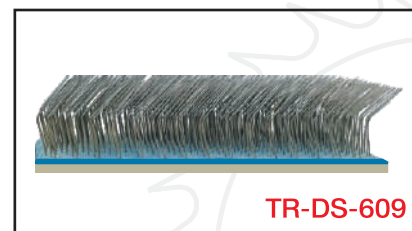
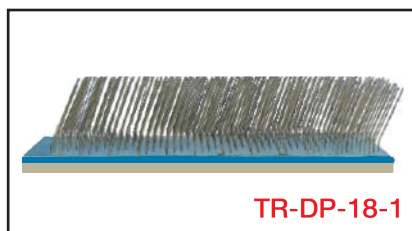
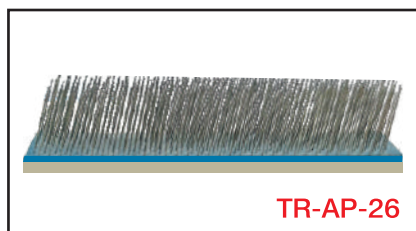
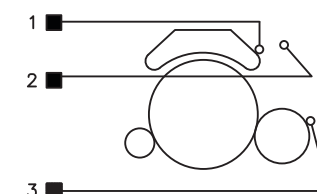

# Carding Plates (Steel & Aluminium)

## Salient Features

- ❖ Carding Plates (Top / Middle / Bottom) made out of High grade Steel materials
- ❖ Aluminium Plates made out of High grade aluminium alloy extrusion
- ❖ Manufactured by precision machines to obtain perfect inner radius and accuracy
- ❖ Perfect design with stiffener ensures longlife and good rigidity
- ❖ Smooth surface ensures burr free to avoid fibre sticking and loading

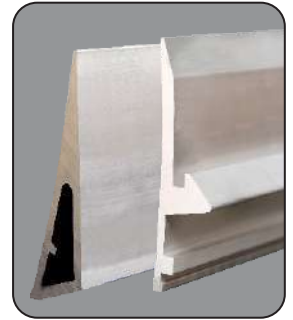
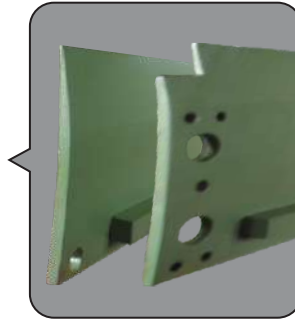

STEEL PLATE - ORIGINAL MACHINE		
C4 / C4A / C10		
S.No.	Description	Drawing No.
A	FRONT - TOP PLATE	Sanmit-A-1001-508
B	FRONT - BOTTOM PLATE	Sanmit-A-1002-509
C	BACK - TOP PLATE	Sanmit-A-1003-510
D	BACK - MIDDLE PLATE	Sanmit-A-1004-511
E	BACK - BOTTOM PLATE	Sanmit-A-1005-520
F	LICKER - IN SHEET	Sanmit-A-1006-884
G	TONGUE PLATE - LICKER - IN	Sanmit-A-1007-885
C10		
A	LICKER - IN COVER FRONT	Sanmit-A-1008-488
B	LICKER - IN COVER BACK	Sanmit-A-1009-489
C	FRONT - MIDDLE PLATE	Sanmit-A-1010-491
C50 & C51		
A	FRONT & BACK BOTTOM PLATE	Sanmit-A-1011-523
B	FRONT & BACK TOP PLATE	Sanmit-A-1012-524
C	LICKER - INCOVER FRONT	Sanmit-A-1013-550
D	LICKER - INCOVER BACK	Sanmit-A-1014-551
HOWA CMS80		
A	FRONT - TOP PLATE	Sanmit-A-1015-327
B	FRONT - BOTTOM PLATE	Sanmit-A-1016-326
C	BACK - TOP PLATE	Sanmit-A-1017-329
D	BACK - BOTTOM PLATE	Sanmit-A-1018-328
HOWA CMSK3		
A	BACK - BOTTOM PLATE	Sanmit-A-1019-330
B	FRONT - BOTTOM PLATE	Sanmit-A-1020-394
C	BACK - TOP PLATE	Sanmit-A-1021-331
D	BACK - BOTTOM PLATE	Sanmit-A-1022-395
C.1/3		
A	FRONT - TOP PLATE	Sanmit-A-1023-1007
B	FRONT - BOTTOM PLATE	Sanmit-A-1024-802
C	BACK - TOP PLATE	Sanmit-A-1025-183
D	BACK - BOTTOM PLATE	Sanmit-A-1026-181
E	LICKER - IN COVER	Sanmit-A-1027-1370
LC 300A - V3 & V4		
A	FRONT - TOP PLATE	Sanmit-A-1028-1185
B	FRONT - BOTTOM PLATE (200 mm)	Sanmit-A-1029-1010
C	BACK - TOP PLATE	Sanmit-A-1030-1186
D	BACK - BOTTOM PLATE	Sanmit-A-1031-1187
E	LICKER - IN COVER	Sanmit-A-1032-1188
D-K803 - Twin Flat		
A	FRONT - BOTTOM PLATE	Sanmit-A-1033-945
B	BACK - BOTTOM PLATE	Sanmit-A-1034-944
ALUMINIUM PLATE - ORIGINAL MACHINE		
D-K740 Cast Iron Base		
S.No.	Description	Drawing No.
A	FRONT-TOP PLATE	Sanmit-B-2001-714
B	FRONT-MIDDLE PLATE	Sanmit-B-2002-718
C	FRONT-BOTTOM PLATE	Sanmit-B-2003-715
D	BACK-TOP PLATE	Sanmit-B-2004-716
E	BACK-BOTTOM PLATE	Sanmit-B-2005-723

D-K760 Cast Iron Base		
A	FRONT - TOP PLATE	Sanmit-B-2006-722
B	FRONT - MIDDLE PLATE	Sanmit-B-2007-717
C	FRONT - BOTTOM PLATE	Sanmit-B-2008-715
D	BACK - TOP PLATE	Sanmit-B-2009-716
E	BACK - MIDDLE PLATE	Sanmit-B-2010-724
F	BACK - BOTTOM PLATE	Sanmit-B-2011-723
D-K760 & 780 Twin Flat		
A	FRONT - BOTTOM PLATE	Sanmit-B-2012-684
B	BACK - BOTTOM PLATE	Sanmit-B-2013-685
D-K760 & 780 Alu Base (SFD & SFL)		
A	FRONT - TOP PLATE	Sanmit-B-2014-720
B	FRONT - MIDDLE PLATE	Sanmit-B-2015-713
C	FRONT - BOTTOM PLATE	Sanmit-B-2016-719
D	BACK - TOP PLATE	Sanmit-B-2017-721
E	BACK - MIDDLE PLATE	Sanmit-B-2018-711
F	BACK - BOTTOM PLATE	Sanmit-B-2019-712
D-K800 Twin Flat		
A	FRONT - TOP PLATE	Sanmit-B-2020-1043
B	FRONT - BOTTOM PLATE	Sanmit-B-2021-1042
C	BACK - TOP PLATE	Sanmit-B-2022-1045
D	BACK - BOTTOM PLATE	Sanmit-B-2023-1044
D-K803 - 3F Alu. Base (SFL)		
A	FRONT - TOP PLATE	Sanmit-B-2024-720
B	FRONT - MIDDLE PLATE	Sanmit-B-2025-713
C	FRONT - BOTTOM PLATE	Sanmit-B-2026-719
D	BACK - TOP PLATE	Sanmit-B-2027-721
E	BACK - MIDDLE PLATE	Sanmit-B-2018-711
F	BACK - BOTTOM PLATE	Sanmit-B-2028-886
D-K803 & 903 Twin Flat		
A	FRONT - BOTTOM PLATE	Sanmit-B-2029-684
B	BACK - BOTTOM PLATE	Sanmit-B-2030-686
T-C03		
A	BACK - BOTTOM PLATE	Sanmit-B-2031-544
TC05 / 07 / 08 / 10 Card		
A	BACK - BOTTOM PLATE	Sanmit-B-2032-1112
C10		
A	LICKER - IN COVER PLATE	Sanmit-B-2033-490
B	FRONT - BOTTOM PLATE	Sanmit-B-2034-1114
C50 & C51		
A	FRONT - BOTTOM PLATE	Sanmit-B-2035-1000
B	BACK - BOTTOM PLATE	Sanmit-B-2036-999
C	LICKER - IN PLATE	Sanmit-B-2037-552
C60		
A★	FRONT & BACK - TOP PLATE (117.2 mm)	Sanmit-B-2038-540
A★	FRONT & BACK - TOP PLATE (136 mm)	Sanmit-B-2039-1399
B	BACK - BOTTOM PLATE	Sanmit-B-2040-542
HOWA CMH & CMS80		
A	FRONT - TOP PLATE	Sanmit-B-2041-746
B	FRONT - BOTTOM PLATE	Sanmit-B-2042-745
C	BACK - TOP PLATE	Sanmit-B-2043-748
D	BACK - BOTTOM PLATE	Sanmit-B-2044-747

MK4 & MK5		
A	FRONT - TOP PLATE	Sanmit-B-2045-499
B	FRONT - BOTTOM PLATE	Sanmit-B-2046-500
C	BACK - TOP PLATE	Sanmit-B-2047-497
D	BACK - BOTTOM PLATE	Sanmit-B-2048-498
MK4 & MK5 - Clip Type		
A	FRONT - TOP PLATE	Sanmit-B-2049-879
B	FRONT - BOTTOM PLATE	Sanmit-B-2050-880
C	BACK - TOP PLATE	Sanmit-B-2051-876
D	BACK - BOTTOM PLATE	Sanmit-B-2052-877
MK5A - Card		
A	BACK - BOTTOM PLATE	Sanmit-B-2053-1195
MK6		
A	BACK - BOTTOM PLATE	Sanmit-B-2054-898
B	FRONT - TOP PLATE	Sanmit-B-2055-899
MK7		
A	FRONT-TOP PLATE	Sanmit-B-2056-972
B	FRONT-BOTTOM PLATE	Sanmit-B-2057-974
C	BACK-TOP PLATE	Sanmit-B-2058-972
D	BACK-BOTTOM PLATE	Sanmit-B-2059-973
LC300A V3 & V4 Card		
A	FRONT-TOP PLATE	Sanmit-B-2060-1189
B	FRONT-BOTTOM PLATE (200 mm)	Sanmit-B-2061-1008
C	BACK-TOP PLATE	Sanmit-B-2062-1191
D	BACK-BOTTOM PLATE	Sanmit-B-2063-1192
LC333 Card		
A	BACK - BOTTOM PLATE	Sanmit-B-2064-1375
SANMIT C-SYSTEM - PLATE		
D-K740		
A	FRONT - TOP PLATE	Sanmit-C-3001-507
B	BACK - BOTTOM PLATE	Sanmit-C-3002-108
D-K760 (Cast Iron Base)		
A	BACK - BOTTOM PLATE	Sanmit-C-3003-533
B	FRONT - MIDDLE PLATE	Sanmit-C-3004-534
D-K760 Card (Twin flat)		
A	FRONT - BOTTOM PLATE	Sanmit-C-3005-677
B	BACK - MIDDLE PLATE	Sanmit-C-3006-679
D-K780		
A	BACK - BOTTOM PLATE	Sanmit-C-3007-106
LC 300A-V3-V4 / C.1-2 & C.1-3		
A	FRONT - BOTTOM PLATE	Sanmit-C-3008-175
B	BACK - BOTTOM PLATE	Sanmit-C-3009-181
C	BACK - TOP PLATE	Sanmit-C-3010-183
C10		
A	FRONT - TOP PLATE	Sanmit-C-3011-865
B	BACK - MIDDLE PLATE	Sanmit-C-3012-867
C	BACK - BOTTOM PLATE	Sanmit-C-3013-506
<b>Also Available for Sanmit C System Plates Howa, Toyada Meikin &amp; Chinese Models</b>		

★ Check with Customer



# Steel Mote Knives

## Salient Features

- ❖ Mote Knives made out of high grade alloy steel material En8 / En31.
- ❖ Smooth finish grinding with Hard Chrome Plating ensures smooth fibre transfer.
- ❖ Hardened to 58 to 60 HRC will ensures long life.
- ❖ Precision dimensional accuracy as per OEM ensures perfect fitment to reduce machine downtime & Long life with competitive price.
- ❖ Special knives can be manufactured as per customer requirement for all machines.



BLOW ROOM MOTE KNIFE			
S.No	Blowroom Model	Type	Drawing No
1	CVT 3 & CVT 4	1st Roller Knife	SANMIT - BR - 1001-626
		2nd Roller Knife	SANMIT - BR - 1002-627
		3rd Roller Knife	SANMIT - BR - 1003-626
2	KIRSCHNER BEATER	1st Roller Knife	SANMIT - BR - 1004-583
3	ERM 5 / 5	1st Roller Knife	SANMIT - BR - 1005-622
4	ERM 5 / 6	1st Roller Knife	SANMIT - BR - 1006-623
ORIGINAL MACHINE			
LC 300 / 300A / 300A-V3 & 300A-V4			
A	FRONT C-SYSTEM M/C Original for LC300	SANMIT - D - 4001-588	
B	BACK C-SYSTEM M/C Original for LC300	SANMIT - D - 4002-589	
C	FRONT-TOP KNIFE	SANMIT - D - 4003-364	
D	BACK-TOP KNIFE	SANMIT - D - 4004-364	
E	BACK-BOTTOM KNIFE	SANMIT - D - 4005-364	
F	UNDER LICKER-IN	1st Knife	SANMIT - D - 4006-274 ( 12 mm)
G			SANMIT - D - 4007-729 ( 15 mm)
H		2nd Knife	SANMIT - D - 4008-687 ( 5 mm)
I			SANMIT - D - 4009-273 ( 8 mm)
J			SANMIT - D - 4010-590 ( 5 mm)
K	UNDER LICKER-IN For LC300	SANMIT - D - 4011-591 ( 8 mm)	
LC 333 / 361 & 363			
A	FRONT-TOP KNIFE	SANMIT - D - 4012-582	
B	FRONT-BOTTOM KNIFE	SANMIT - D - 4013-582	
C	BACK-TOP KNIFE	SANMIT - D - 4014-364	
D	BACK-BOTTOM KNIFE	SANMIT - D - 4015-364	
E	UNDER LICKER-IN	1st Knife	SANMIT - D - 4016-801 ( 8.5 mm)
F			SANMIT - D - 4016-1094 ( 12 mm)
G		2nd Knife	SANMIT - D - 4016-1267 ( 16 mm)
H			SANMIT - D - 4017-803 ( 5 mm)
C.1 / 2 & C.1/3			
A	FRONT-TOP KNIFE	SANMIT - D - 4018-364	
B	BACK-TOP KNIFE	SANMIT - D - 4019-364	
C	UNDER LICKER-IN	1st Knife	SANMIT - D - 4020-274 ( 12 mm)
D			SANMIT - D - 4021-729 ( 15 mm)
E		2nd Knife	SANMIT - D - 4022-687 ( 5 mm)
F			SANMIT - D - 4023-273 ( 8 mm)
G			SANMIT - D - 4023-1139 (10mm)
LC100			
A	FRONT-TOP KNIFE	SANMIT - D - 4024-580	
B	UNDER LICKER-IN	SANMIT - D - 4025-451	
D-K740			
A	BACK-TOP KNIFE	SANMIT - D - 4026-492	
B	LCC C-FACTOR	SANMIT - D - 4027-826	
C	FEEDER ROLLER KNIFE (BEFORE UNDER COMBING SEGMENT)	SANMIT - D - 4028-577 (20 mm)	
D-K760 ( CAST IRON BASE )			
A	BACK-TOP KNIFE	SANMIT - D - 4029-828	
B	FRONT-TOP KNIFE	SANMIT - D - 4030-829	
C	FRONT-BOTTOM KNIFE	SANMIT - D - 4031-830	
D-K760, D-K780 (3 Flat C-System) D-K800 (Twin flat)			
A	FRONT-TOP KNIFE	SANMIT - D - 4032-495	
B	FRONT-BOTTOM KNIFE	SANMIT - D - 4033-495	
C	BACK-TOP KNIFE	SANMIT - D - 4034-494	
D	I.C.C NEW C - SYSTEM SUCTION KNIFE	SANMIT - D - 4035-494	
E	L.C.C C - FACTOR	SANMIT - D - 4036-494	
F	UNDER LICKER-IN	1st Knife	SANMIT - D - 4037-1345 (8mm)
G		2nd Knife	SANMIT - D - 4038-1347 (5mm)

D-K803 (3 Flat C-System) & D-K903 (Twin Flat System)			
A	FRONT-TOP KNIFE	SANMIT - D - 4039-495	
B	FRONT-BOTTOM KNIFE	SANMIT - D - 4040-495	
C	BACK-TOP KNIFE	SANMIT - D - 4041-494	
D	UNDER LICKER-IN	1st Knife	SANMIT - D - 4042-1365 (9 mm)
E		2nd Knife	SANMIT - D - 4043-1367 (6 mm)
F		3rd Knife	SANMIT - D - 4044-1367 (6 mm)
D-K800			
A	STRIPPING FILLET KNIFE	SANMIT - D - 4045-996	
T-C03 / 05 / 5-3 / 06 / 08			
A	FRONT-TOP KNIFE	SANMIT - D - 4046-538	
B	FRONT-MIDDLE KNIFE	SANMIT - D - 4047-538	
C	FRONT-BOTTOM KNIFE	SANMIT - D - 4048-538	
D	BACK-TOP KNIFE	SANMIT - D - 4049-538	
E	BACK-MIDDLE KNIFE	SANMIT - D - 4050-538	
F	BACK-SUCTION-TOP KNIFE	SANMIT - D - 4051-725	
G	UNDER LICKER-IN for TC03 & TC5/3	SANMIT - D - 4052-1346	
H	UNDER LICKER-IN for TC5 & TC08	SANMIT - D - 4053-1366	
I	UNDER LICKER-IN for TC10	SANMIT - D - 4054-1364	
T-C11			
A	C-SYSTEM-SUCTION HOOD KNIFE	SANMIT - D - 4055-864	
T-C360			
A	UNDER LICKER-IN KNIFE	SANMIT - D - 4056-578	
C4			
A	FRONT-ECC KNIFE	SANMIT - D - 4057-672	
B	FRONT-ICC KNIFE	SANMIT - D - 4058-673	
C	BACK-ECC KNIFE	SANMIT - D - 4059-672	
D	BACK-ICC KNIFE	SANMIT - D - 4060-673	
E	UNDER LICKER-IN	1st Knife	SANMIT - D - 4061-576 ( 8 mm)
F		2nd Knife	SANMIT - D - 4062-576 ( 8 mm)
C50 & C51			
A	FRONT-TOP KNIFE	SANMIT - D - 4063-619	
B	FRONT-BOTTOM KNIFE	SANMIT - D - 4064-619	
C	BACK-TOP KNIFE	SANMIT - D - 4065-619	
D	UNDER LICKER-IN	1st Knife	SANMIT - D - 4066-620 (10 mm)
E		2nd Knife	SANMIT - D - 4067-620 (10 mm)
C60 & C601			
A	FRONT & BACK SUCTION HOOD KNIFE	SANMIT - D - 4068-1319	
B	UNDER LICKER-IN	1st Knife	SANMIT - D - 4069-1306
C		2nd Knife	SANMIT - D - 4070-1320
C70 & C72			
A	FRONT & BACK SUCTION HOOD KNIFE	SANMIT - D - 4071-1369	
B	UNDER LICKER-IN	SANMIT - D - 4072-1368	
MK4			
A	UNDER LICKER-IN KNIFE	SANMIT - D - 4073-264	
MK5 & MK6			
A	FRONT-KNIFE	SANMIT - D - 4074-780	
B	BACK-KNIFE	SANMIT - D - 4075-780	
C	UNDER LICKER-IN TRASH - KNIFE	SANMIT - D - 4076-496 ( 6 mm)	
D	UNDER LICKER-IN	SANMIT - D - 4077-455 (10 mm)	
HOWA			
A	UNDER LICKER-IN KNIFE	SANMIT - D - 4078-587	
CHINESE			
A	UNDER LICKER-IN KNIFE - FA221-D	SANMIT - D - 4079-628	
B	UNDER LICKER-IN KNIFE - FA225	SANMIT - D - 4080-980	
SANMIT C - SYSTEM KNIVES			
A	LC300A / V3 / V4 & C.1/2, C.1/3	SANMIT - E - 5001-173	
B	D-K740, 760, 780, 800, 803 & 903	SANMIT - E - 5002-102	

# Brush Conversion Kit

T-C03 / 05 / 07 / 08 / 10 / 11 / 15



D-K 715 / 740 / 760 / 780 / 800 / 803 & 903

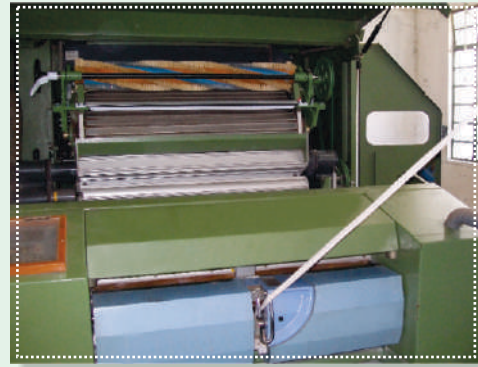

C60 / 61 / 70



C50 / 51



C 4 / C10 & LC333



# Brush Conversion Kit

CHINESE  
40" Width  
JFA221D/JWF1206 / JWF1211 &  
Other Chinese Cards  
50" Width  
JWF1213 / JWFA326 / JSFA328A



MK4 / MK6 / MK7



ACCESSORIES



## FLAT CLEANING BRUSH & COMBER BRUSH

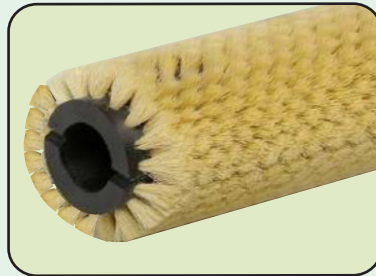
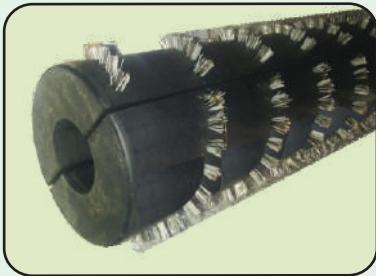

MARZOLI - CX300 / CX401 / CX501 (Only Philipson Brush for Replacement)

## BRUSH PULLEY CONVERSION KIT (Drive from Cylinder)

Gear Box will be Removed

LC300 / 300A / 300A-V3 / 300A-V4 / 361



### Salient Features

- ❖ Gear Box drive for existing Brush conversion will be removed.
- ❖ Drive will be from Main Cylinder
- ❖ Substantial Power Saving due to removal of gear box motor.
- ❖ Low maintenance due to removal of gear box
- ❖ During power cut, revolving flat will be clean till Cylinder stops.

# Carding Accessories

## STEEL MOTE KNIVES for C60 & 601

Existing Machine Original base with Aluminium Knife

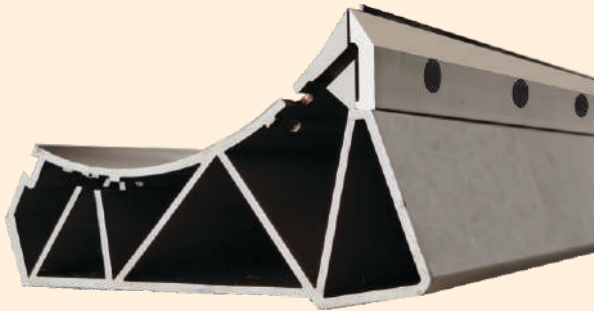

Sanmit Hardened Steel Knife with Machine Original Base

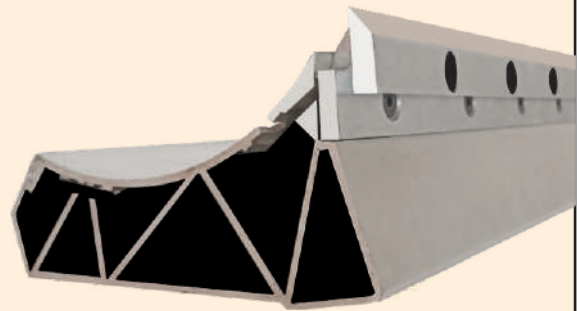

## ALUMINIUM WASTE CONTROL SHEET

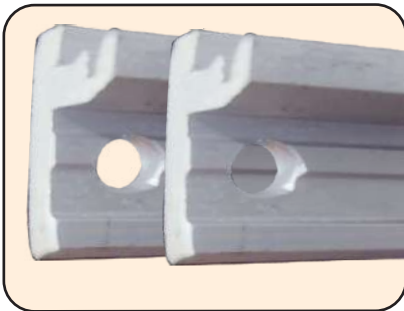

C60 / C70 / C72	Sanmit Drawing No.
No.8	Sanmit - C60 - 546
No.5	Sanmit - C60 - 547
No.2	Sanmit - C60 - 548
No.0	Sanmit - C60 - 625

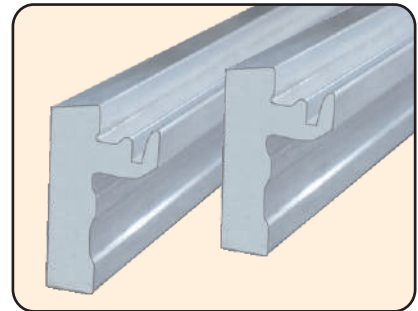

## HAND CARD STRIPPING FILLET

S.No.	Description	Specification
1	Hand Card Stripper with Clips	260 x 64 x 17 mm
2	Handle for Hand Card Stripper	
3	Hand Card Stripper (use with Wooden Handle)	560 x 64 x 17 mm
4	Metallic Stripping Fillet	14 mtrs x 40 mm

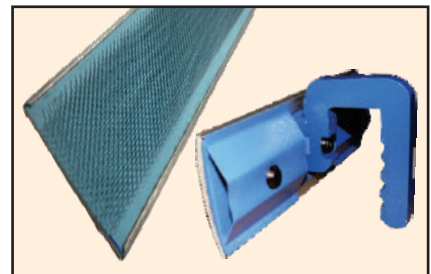

## BURNISHING PAD & HANDLE

S.No.	Description	Specification
1	Burnishing Pad	200 x 100 x 25 mm
2	Handle for Burnishing Pad	-
3	Emery Fillet	-

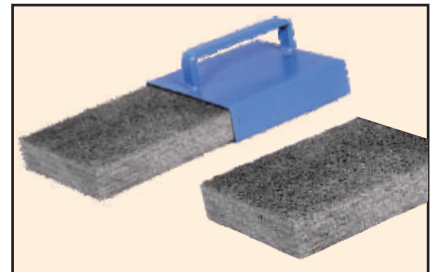

## LEAF GAUGES

S.No.	Description	Specification
1	7 Leaf Gauge	300 mm x 30 mm 400 mm x 30 mm
2	Single Leaf Gauge	300 mm x 30 mm
3	Flat Gauge	6/1000, 7/1000, 8/1000, 9/1000, 10/1000, 12/1000



# Metallic Wire For Flat Card

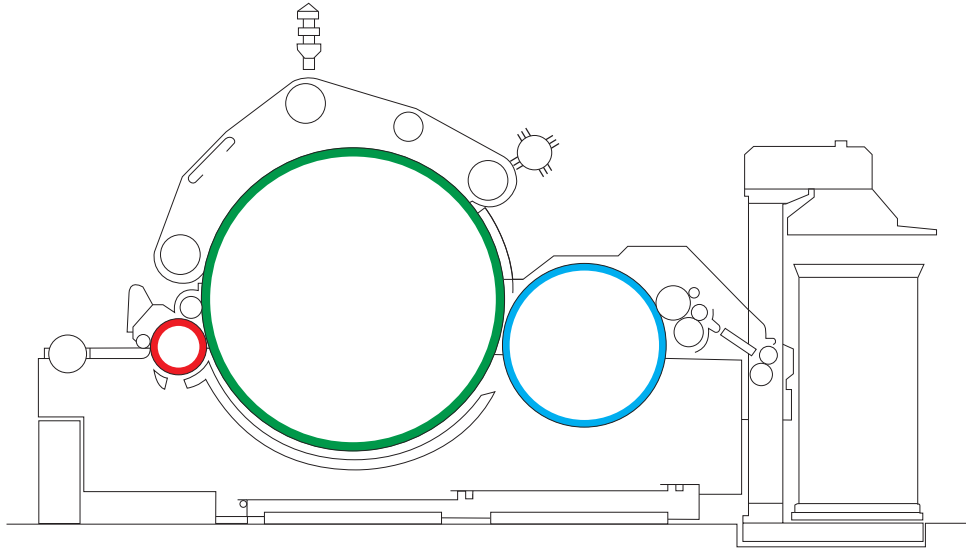

## ○ Cylinder Wires

S.No	Type	Height	Rib	Angle $\alpha$	PPSI	
1	CK7-2035 x 0.4	2.0	0.4	35	1080	
2	CK7-2040 x 0.4	2.0	0.4	40	1080	
3	CK9-2030 x 0.5	2.0	0.5	30	990	
4	CK5-2035 x 0.4	2.0	0.4	35	960	
5	CK5-2040 x 0.4	2.0	0.4	40	960	
6	CK7-2025 x 0.5	2.0	0.5	25	860	
7	CK7-2030 x 0.5	2.0	0.5	30	860	
8	CK7-2035 x 0.5	2.0	0.5	35	860	
9	CK7-2040 x 0.5	2.0	0.5	40	860	
10	CK6-2025 x 0.5	2.0	0.5	25	810	
11	CK7-2030 x 0.6	2.0	0.6	30	720	
12	CK7-2530 x 0.5	2.5	0.5	30	860	
13	CK6-2530 x 0.5	2.5	0.5	30	760	
14	CK7-2530 x 0.6	2.5	0.6	30	720	
15	CK7-2525 x 0.6	2.5	0.6	25	720	
16	CK7-2520 x 0.6	2.5	0.6	20	720	
17	CK5-2520 x 0.7	2.5	0.7	20	550	
18	CK7-2520 x 0.7	2.5	0.7	20	620	
19	CK7-2820 x 0.7	2.8	0.7	20	620	
20	CK9-2815 x 0.8	2.8	0.8	15	480	
21	CK4-3210 x 0.9	3.2	0.9	10	400	

# Metallic Wire For Flat Card

## ○ Doffer Wires

S.No	Type	Height	Rib	Angle $\alpha$	PPSI	
1	DK3-4030 x 0.85 R	4.0	0.85	30	390	
2	DK0-4030 x 0.9 RC	4.0	0.85	30	310	
3	DK0-4035 x 0.8 UC	4.0	0.8	35	320	
4	DK0-4030 x 1.0 RC	4.0	1.0	30	280	
5	DK2-4730 x 1.0	4.7	1.0	30	305	
6	DK2-5030 x 0.9	5.0	0.9	30	340	

## ○ Licker-in Wires - Interlocking

S.No	Type	Height	Rib	Angle $\alpha$	TPI	
1	TA-V8 - D5005	5.0	V8	5	4.0	
2	TA-V8 - E5010	5.0	V8	10	5.0	
3	TA-V8 -E5000	5.0	V8	0	5.0	
4	TA-V12 J2-5010	5.0	V12	10	9.5	
5	TA-V16 K-5020	5.0	V16	20	10.0	
6	TA-V16 N-5020	5.0	V16	20	13.0	

## ○ Licker-in Wires - Grooved





S.No	Type	Height	Rib	Angle $\alpha$	TPI	
1	TA-C 5005	5.5	1.1 to 1.6	0	3	
2	TA-D5505	5.5	1.1 to 1.6	5	4	
3	TA-E5510	5.5	1.1 to 1.6	10	5	

## Take-off Roller Wire

S.No	Type	Height	Rib	Angle $\alpha$	TPI	PPSI	
1	NA75-42120	4.2	1.8	120	7.5	110	
2	NA7-42117	4.2	1.8	117	7	99	
3	NA55-40110	4.0	1.6	100	6.5	87	

# Metallic Wire For Flat Card

## Blow Room Wire

S.No	Type	Height	Rib	Angle 	TPI	PPSI	
1	NA127-1080	10.0	2.5	10	1.27	14	
2	NA25-1080	10.0	2.5	10	2.5	26	

## Blowroom Beater Wires

S.No	Type	Height	Rib	Angle 	TPI
1	B-TR13 & 14	7.5	V6	10	1.5
2	B-V8 D6020	6.0	V8	20	4
3	B-V6 C6020	6.0	V6	20	3
4	B-BR 10/0	10	2.5	0	2.5
5	B-BR 10/10	10	2.5	10	2.5
6	B-BR20/0	10	2.5	0	1.5
7	B-BR20/10	10	2.5	10	1.5

## Border Wires

S.No	Type	Height	Rib	TPI
1	Steel Border Wire - 4.0 x 1.0	4	1.0	0.0
2	Anti Flock Border Wire - 1501	3.2	1.2	2.5
3	Anti Flock Border Wire - 1504	6.2	0.5	4

## Blowroom Beater Wires

S.No	Type	Height	Rib	Angle 	TPI
1	Stripper Wire TR12 - SG2 4028 x 1.8	4.0	1.8	-28	7.5
2	Stripper Wire - H3530 x 1.0	3.5	1.0	-30	8.0
3	Feed Roller Wire - FV6-TR5	5	4.2	15	2.0
4	Chute Beater Wire-TR11	5.5	V6	0	4.5
5	J 2500 x 2.0	2.5	2.0	0	9
6	F <sub>2</sub> 3500 x 3.0	3.5	3.0	0	6.5

## **SOLUTION for Minimum Replacement Cost & Maximum Benefits**

To Maintain Consistent Quality & Long Life -  
Replace the following Products as per OEM Schedule

- ❖ **Stationary Flat Tops**
- ❖ **Aluminium Plates**
- ❖ **Steel Plates**
- ❖ **Mote Knives**
- ❖ **Fillets**



## **Sanmit Card Clothing India (P) Ltd**

Fact. & Admn. Off. : S.F. No. : 61/2, Plot No. 41,  
Mahatma Gandhi Road, S.I.H.S Colony Road (Via),  
Neelikonampalayam (P.O.), Coimbatore - 641 033, INDIA.

Mobile : +91 95009 90591  
+91 87540 44138  
+91 87540 44130



Email : ram@sanmitcard.com  
info@sanmitcard.com  
prabu@sanmitcard.com  
sales@sanmitcard.com

Web : www.sanmitcard.com